

# Retro-reflective sensors with coaxial optics, in a metal housing



- Robust die-cast zinc housing
- Light reserve warning indicator
- Dual transistor outputs, NPN or PNP
- Short-circuit protection, reverse polarity protection, and power-up output suppression
- Test input (option)
- Connections: Cable, 2 meter  
Connector, M8  
Connector, Torson, on 20 cm long cable (option)
- EMC tested according to IEC 801 and EN50081-1/EN 50082-2



## Product designation<sup>1)</sup>

Output
Connection
Range adjustment

## Optical data<sup>2)</sup>

Range
Emitter

## Electrical data<sup>2)</sup>

Supply voltage $U_s$
Allowable ripple
Current consumption (without load)
Max. load current $I_L$
Residual voltage
Max. switching frequency

## Environmental data

Sealing
Temperature $T_A$ (operating and storage)
Weight

## Option<sup>1)</sup>

Test input: emitter on
emitter off

ORA 2NA 100 I3	ORA 2NA 500 I3	ORA 2PA 100 I3	ORA 2PA 500 I3
NPN (light- and dark-on)		PNP (light- and dark-on)	
Cable 2 m	Connector M8	Cable 2 m	Connector M8
Yes			
0...1 m (retroreflector OZR 001)			
Infrared-LED, 950 nm, pulsed			
10...45 VDC			
+/- 10% of $U_s$			
< 20 mA			
250 mA			
< 1,6 V			
1000 Hz			
IP 67			
-20...+60 °C			
ca. 150 g	ca. 85 g	ca. 150 g	ca. 85 g

+ $U_s$ or open	
< 1,5 V	< $U_s$ - 8 V

1) For product designation of sensors with options see designation code on page 67.  
2) When not otherwise noted, all technical data at  $T_A = 25\text{ °C}$  and  $U_s = 24\text{ V}$ .

## ORA as a code reader

The retro-reflective sensor with coaxial optics is particularly suitable for simple identification applications. For identification purposes a code raster, created from retroreflective tape OZR 201 and nonreflecting surfaces, is necessary. The range for reading this code is dependent on the raster width (↔ Optical resolution).

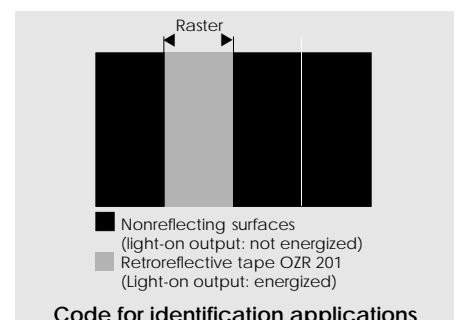
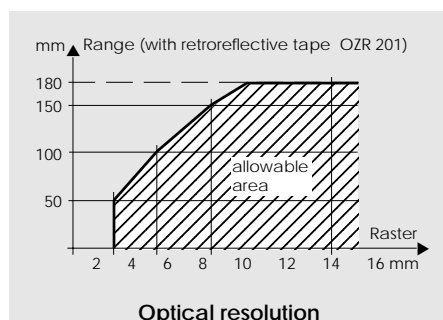

10...45 VDC

NPN / PNP  
light-on and  
dark-on output

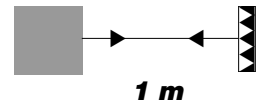

# ORA code reader

## Dimensions (50 mm x 44,5 mm x 12 mm)

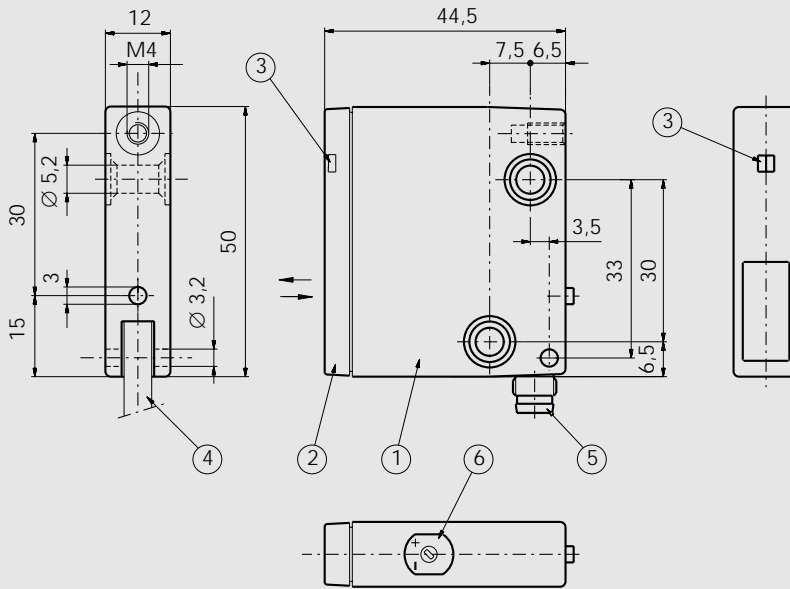

- ① Housing
- ② Lens/filter
- ③ Function indicator
- ④ Cable
- ⑤ Connector M8
- ⑥ Range adjustment

## Optical diagrams

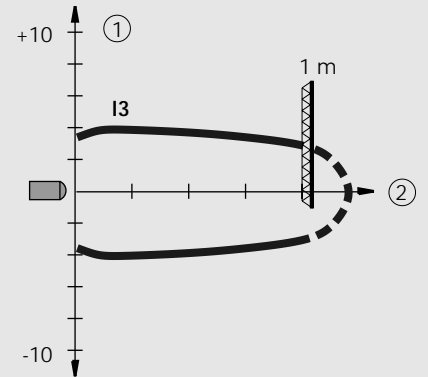

Typical beam diameter  
(with retroreflector OZR 001)

- ① Diameter in (cm)
- ② Range in (m)

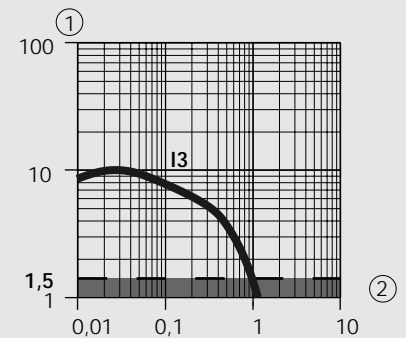

Typical excess gain curve  
(with retroreflector OZR 001)

- ① Gain factor
- ② Range in (m)

## Wiring diagram

### NPN output

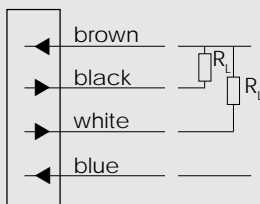

⊕ Supply voltage 10...45 V  
Light-on output  
Dark-on output  
⊖ Supply voltage

### PNP output

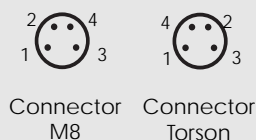
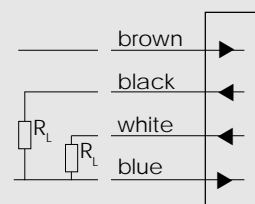

Connection for connector M8	Wire color	Connection for test input
1	brown	Supply+
2	white	Test input
3	blue	Supply-
4	black	Output

Light-on output:  
Output energized when no object is present.

Dark-on output:  
Output energized when object is present.